

Data sheet | Item number: 222-415

CLASSIC Splicing Connector; for all conductor types; max. 4 mm²; 5-conductor; with levers; gray housing; Ambient temperature: max. 40 °C

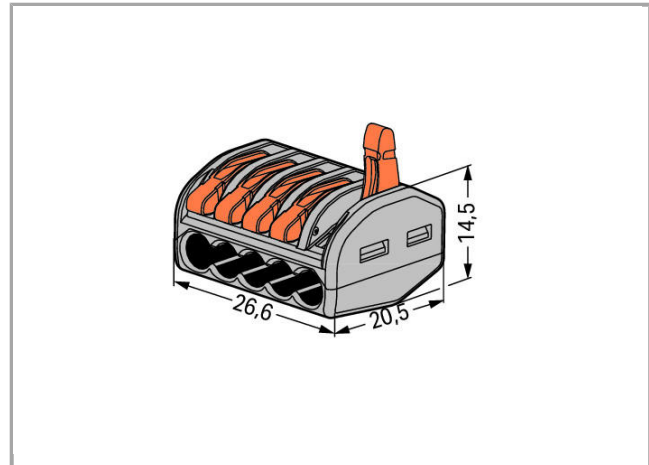

222-415



Item description

Safety information 1:
In grounded power lines

Data

Electrical data

Ratings per IEC/EN 60664-1

Rated voltage (II / 2)	400 V
Rated impulse voltage (II / 2)	4 kV
Rated current	32 A

Connection data

Connection technology	CAGE CLAMP®
Actuation type	Lever
Connectable conductor materials	Copper
Solid conductor	0.08 ... 2.5 mm ² / 28 ... 12 AWG

Stranded conductor	0.08 ... 2.5 mm ² / 28 ... 12 AWG
Fine-stranded conductor	0.08 ... 4 mm ² / 28 ... 12 AWG
Strip length	9 ... 10 mm / 0.35 ... 0.39 inch
Total number of connection points	5
Total number of potentials	1
Type of wiring	Side-entry wiring

Geometrical Data

Width	26.6 mm / 1.047 inch
Height	14.5 mm / 0.571 inch
Depth	20.5 mm / 0.807 inch

Material Data

Color	gray
Flammability class per UL94	V0
Fire load	0.13 MJ
Weight	6.581 g

Environmental Requirements

Surrounding air (operating) temperature	40 °C
Continuous operating temperature	85 °C

Commercial data

Product Group	7 (Push Wire Conn.)
Country of origin	DE
GTIN	4044918464956
Customs Tariff No.	85369010000

Approvals / Certificates

Country specific Approvals

Logo	Approval	Additional Approval Text	Certificate name
	ENEC 15 UL International Demko A/S	EN 60998	ENEC-01360

Ship Approvals

Logo	Approval	Additional Approval Text	Certificate name
	ABS American Bureau of Shipping	-	18-HG1755093-



	DNV GL Det Norske Veritas, Germanischer Lloyd	EN 60998	TAE000015T
--	---	----------	------------





	LR Lloyds Register	EN 60998	04/20013 (E6)
--	------------------------------	----------	------------------



	LR Lloyds Register		04/20013 (E4)
--	------------------------------	--	------------------





UL-Approvals

Logo	Approval	Additional Approval Text	Certificate name
	UL UL International Germany GmbH	UL 486C	E69654
	UL Underwriters Laboratories Inc.	UL 467	E201573

Compatible products

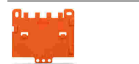
Mounting adapter

	Item no.: 222-500 Mounting carrier; 222 Series; for DIN-35 rail mounting/screw mounting	222-500
	Item no.: 222-505 Strain relief plate; for mounting carrier; 221 or 222 Series, can be snapped	222-505
	Item no.: 222-510 Angled DIN-rail adapter; in combination with mounting carrier; 221-500 or 222-500; for DIN-35 rail mounting	222-510

General accessories

	Item no.: 249-130 Syringe; Contents: 20 ml Alu-Plus contact paste	249-130
--	---	---------



Downloads

Documentation

Bid Text

222-415	Apr 4, 2012	doc	Download
Reihenklemmen, Verbindungsklemmen		25.6 kB	

CAD/CAE - Smart Data

CAD data

3D Download 222-415	URL	Download
---------------------	-----	----------

Subject to changes.
